



宁波莱科液压器材有限公司
NINGBO LAIKE HYDRAULICS CO.,LTD

地址: 宁波市鄞州区横溪工业区岐山路298号

ADD: NO.298,QISHAN ROAD,HENGXI INDUSTRIAL ZONE,YINZHOU DISTRICT,NINGBO,CHINA.

邮编P.C.: 315131

电话(Tel): +86-574-88472489 88471115

传真(Fax): +86-574-88471696

E-mail: laike@nblaike.cn

Http: www.nblaike.cn

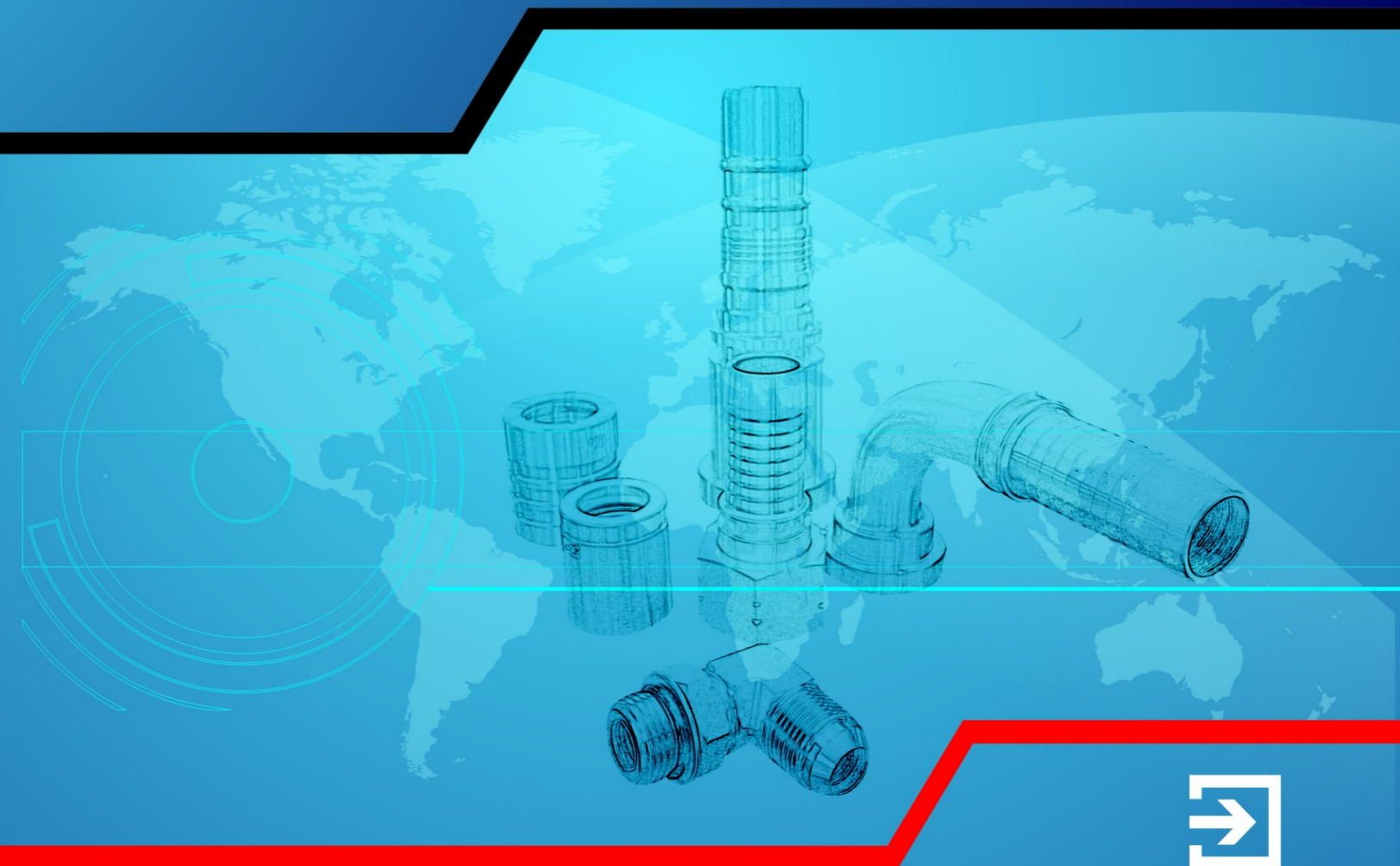

本样本部分产品为客户定制品, 仅作参考。
Parts of products are customized, only for reference

宁波莱科液压器材有限公司
NINGBO LAIKE HYDRAULICS CO.,LTD

公司简介

宁波莱科液压器材有限公司座落于现代化的海滨城市--宁波。是一家致力于液压管件研制、开发与制造的专业公司。公司汇集了业界优秀的专业人才，引进先进的企业管理理念和技术，以精湛的生产工艺和严格的质量管理，为客户制造各种高质量的流体连接件产品。在质量体系的全面规范下，每一个零部件和产品的质量均处于有效的控制之中。同时，公司使用 ERP 系统管理采购、生产、销售、财务各环节，使公司的供应链流程更加通畅。

我公司生产的液压软管接头、过渡接头和软管总成等产品广泛应用于矿山、机械、交通、船舶和油田等行业。所生产的软管接头具有结构优良，设计先进的特点，全部弯形接头都采用整体制造，避免了焊接处可能漏油的缺点；为客户提供的各款软管总成，都经过严格测试，在品质方面提供可靠保证。为了使我们的产品在同行中更具竞争力，所有产品在出厂前均经过严格的出厂检验，确保出厂的产品让客户 100%满意。

我们以“一流的设计，一流的产品，一流的服务”作为公司的经营理念，我们深信我公司的产品一定会成为顾客们的最佳选择。

公司地处宁波鄞州横溪工业区，地理位置优越，交通便利，欢迎各位客商光临洽谈。

COMPANY PROFILE

Ningbo Laike Hydraulic Co., Ltd, located near the Ningbo Port, is committed to developing and manufacturing hydraulic fittings, adapters, hose assemblies and other related products that are widely used in mining, machinery, transportation, shipping, oil fields and other industries.

We entered the hydraulic fitting market in 1995, and soon adopted ISO9001 to improve cross-organization quality management. Later we upgraded ERP system to facilitate inter-department communication and ensure product traceability. We consistently invest on R&D, human talents, and facilities & equipments to develop fluid connectors that exceed customers' demand.

With decades of industry experience, we have become an industry leader. Customers choose us because:

- We improve efficiency and quality by using CNC machine, drill machine, forge machine, etc.
- We can design and manufacture all kinds of hydraulic fittings according to customers' requirement.
- We stock more than 40,000 kinds of hydraulic fittings for quick delivery.
- We conduct 100% quality check to ensure 100% customer satisfaction.

It is the long-standing commitment to "first-class design, first-class products, first-class service" that has made Laike Hydraulics a name synonymous with hydraulic fittings and adapters. We are looking forward to meeting everyone to visit us.





莱科液压
LAIKE HYDRAULICS

扣压式软管接头
SWAGED HOSE FITTING

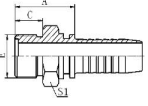
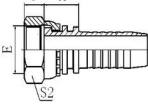
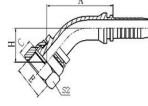
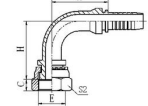
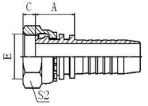
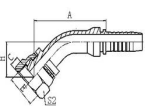
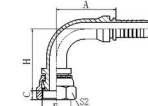
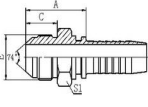
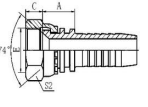
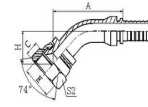
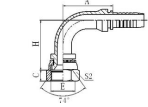
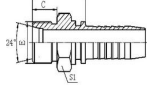
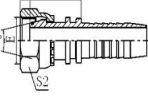
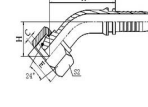
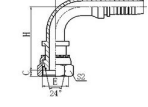
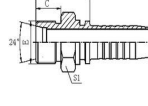
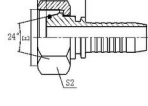
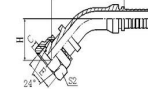
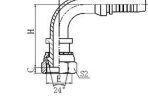
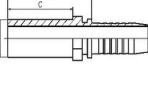
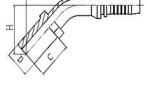
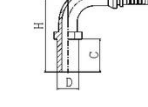
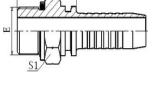
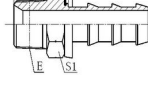

扣压式软管接头
SWAGED HOSE FITTING

公制螺纹 平面密封 Metric Flat Seal				
	10311 10312	20211 20212	20241 20242	20291 20292
公制螺纹 球面密封 Metric Multiseal				
	20111 20112	20141 20142	20191 20192	
公制螺纹 74° 锥密封 Metric 74° Cone Seal				
	10711 10712	20711 20712	20741 20742	20791 20792
公制螺纹 24° 锥密封轻系列 Metric 74° Cone O-Ring Seal L.T.				
	10411 10412	20411 20412	20441 20442	20491 20492
公制螺纹 24° 锥密封重系列 Metric 24° Cone O-Ring Seal H.T.				
	10511 10512	20511 20512	20541 20542	20591 20592
公制卡套直管 Standpipe Straight				
	50011 50012	50041 50042	50091 50092	
英管螺纹O形圈密封 BSP O-Ring Seal				
	12211 12212			
英锥管螺纹 BSPT				
	13011-SP 13012-SP			



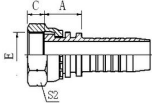
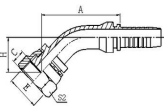
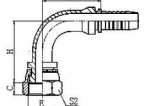
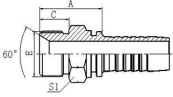
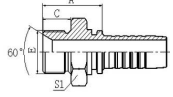
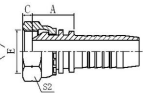
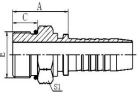
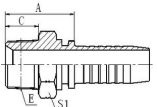
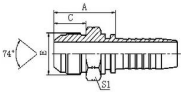
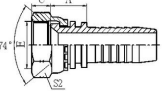
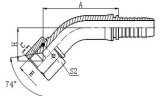
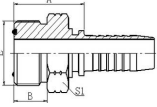
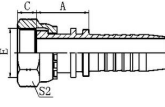
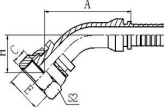

扣压式软管接头
SWAGED HOSE FITTING

<p>英管螺纹 平面密封 BSP Flat Seal</p>	 22211 22212	 22241 22242	 22291 22292
<p>英管螺纹60° 锥面密封 BSP 60° Cone Seal</p>	 12611 12622	 12611A 12612A	 22611 22612 22641 22642
<p>美制SAE螺纹 O形圈密封 SAE O-Ring Seal</p>	 16011 16012		
<p>美制锥螺纹 NPT</p>	 15611 15612		
<p>美制JIC螺纹 74° 锥密封 JIC 74° Cone Seal</p>	 16711 16712	 26711 26712	 26741 26742 26791 26792 26711D 26712D 26711D-SM 26712D-SM
<p>美制ORFS螺纹 平面密封 ORFS Flat Seal</p>	 14211 14212	 24211 24212	 24241 24242 24291 24292

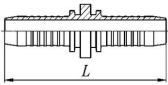
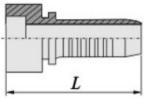
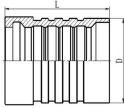

扣压式软管接头
SWAGED HOSE FITTING

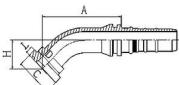
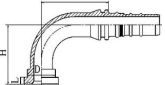
美制NPSM螺纹 60° 锥面密封 NPSM 60° Cone Seal				
	21611 21612	21641 21642	21691 21692	
SAE 法兰轻系列 SAE Flange L.T.				
	87311 87312	87341 87342	87391 87392	FL
SAE 法兰重系列 SAE Flange H.T.				
	87611 87612	87641 87642	87691 87692	FS
日式公制螺纹 60° 锥密封 JIS Metric 60° Cone Seal				
	18611 18612	28611 28612	28641 28642	28691 28692
日式英管螺纹 60° 锥密封 JIS Gas 60° Cone Seal				
	29611 29612	29641 29642	29691 29692	
公制螺纹 水管接头 Metric Waterwash				
	20011-T			
矿用接头 Staplelok				
	67011 67012			
铰接接头 Banjo				
	70011 70012	700M	72011 72012	720B

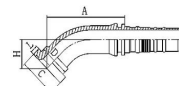
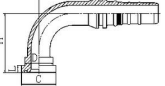
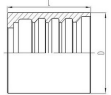
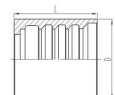
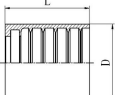
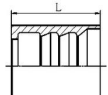
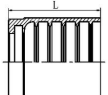
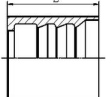
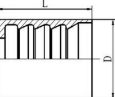
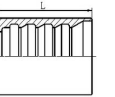
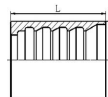
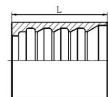
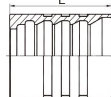
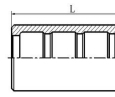
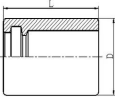
扣压式软管接头 SWAGED HOSE FITTING	双面连接接头 Double Connection		90011 90012
	焊接接头 Welding Hose Fitting		90011N 90012N
剥内外胶软管接头 INTERLOCK HOSE FITTING	套筒 Ferrule		00621
	SAE法兰 SAE Flange	  	87313 87343 87393
		  	87613 87643 87693
套筒 FERRULE		    	01100 01200 00110-A 00110 03310
	套筒 Ferrule	    	00200 00210 01400 00400 00401
		  	00402 00018 00TF0



套筒

FERRULE



莱科液压
LAIKE HYDRAULICS





过渡接头
ADAPTER

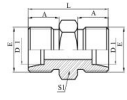
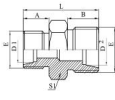
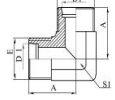
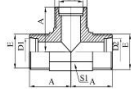
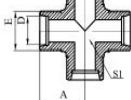
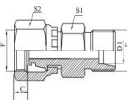
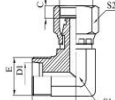
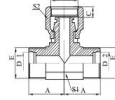
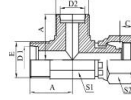
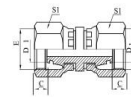
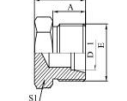
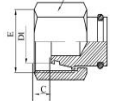
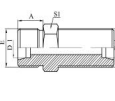
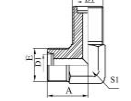
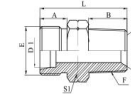
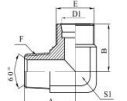
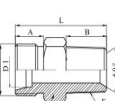
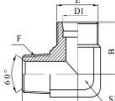
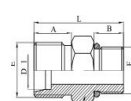
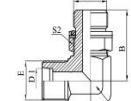
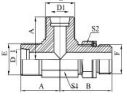
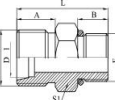
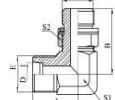
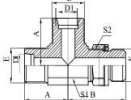
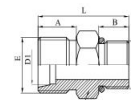
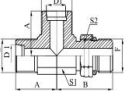
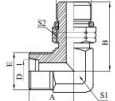
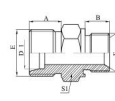
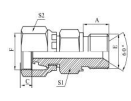
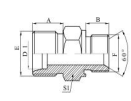
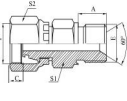
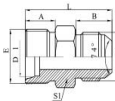
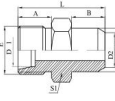
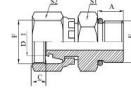
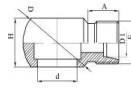
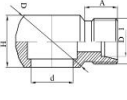

过渡接头
ADAPTER

公制螺纹
卡套密封
Metric Thread
Bite Type
Tube Fitting

				
1C 1D	1C 1D (Reducer)	1C9 1D9	AC AD	XC XD
				
2C 2D	2C9 2D9	BC BD	CC CD	3C 3D
				
4C 4D	9C 9D	6C 6D	6C9 6D9	1CN 1DN
				
1CN9 1DN9	1CT-SP 1DT-SP	1CT9-SP 1DT9-SP	1CH 1DH	1CH9-OG 1DH9-OG
				
ACCH-OG ADDH-OG	1CG 1DG	1CG9-OG 1DG9-OG	ACCG-OG ADDG-OG	1CO 1DO
				
ACCO-OG ADDO-OG	1CO9-OG 1DO9-OG	1CB-WD 1DB-WD	2BC-WD 2BD-WD	1CM-WD 1DM-WD
				
2MC-WD 2MD-WD	1CJ 1DJ	1CW 1DW	2GC 2GD	1CL-B 1DL-B
				
1CL 1DL	NL NS	RL-S RS-S		

过渡接头
ADAPTER

公制螺纹O形圈
平面密封接头
Metric Thread
O-Ring Face
Seal Fitting

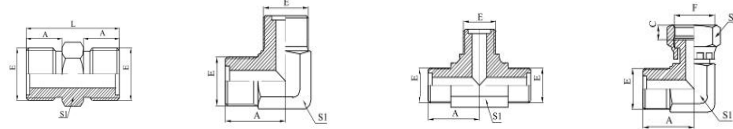

1E 1E9 AE 2E9

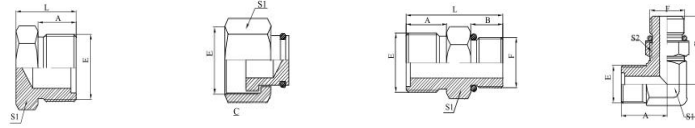

4E 9E 1EH 1EH9-OG

公制螺纹
74° 锥面扩口
密封接头
Metric Thread
74° Cone
Flared Tube
Fitting

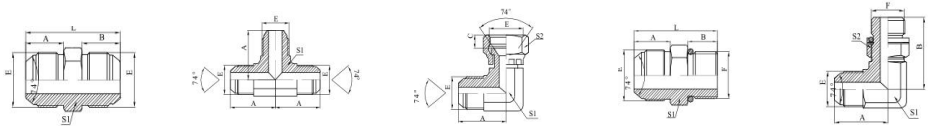

1Q AQ 2Q9 1QH 1QH9-OG

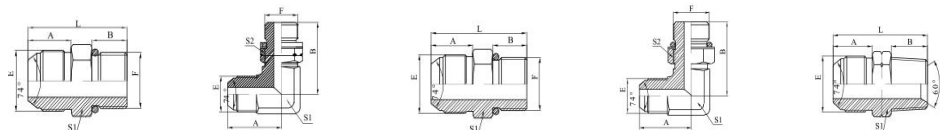

1QG 1QG9-OG 1QO 1QO9-OG 1QN

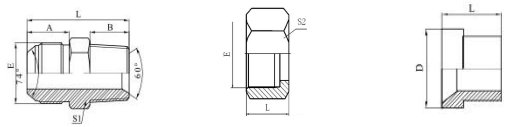

1QT-SP NB200-Q NB500-Q

日本英管螺纹
60° 锥面密封
接头
Japanese 60°
Cone Fitting

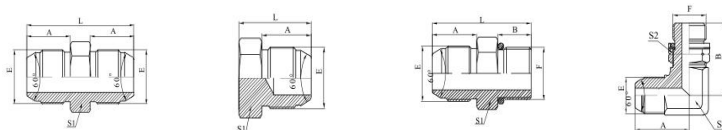

1S 4S 1SG 1SG9-OG

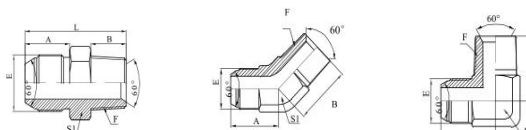

1ST-SP 1ST4-SP 1ST9-SP

英锥管螺纹
BSPT接头
BSPT Thread
Fitting

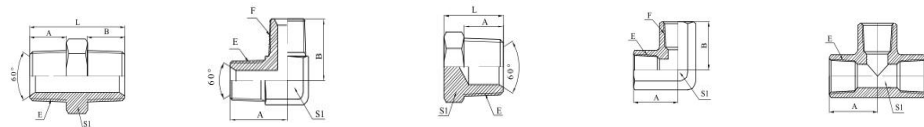

1T-SP 1T9-SP 4T-SP 7T9-PK GT-PK

过渡接头
ADAPTER

英管螺纹
60° 锥面
密封接头
BSP Thread
60° Cone
Fitting

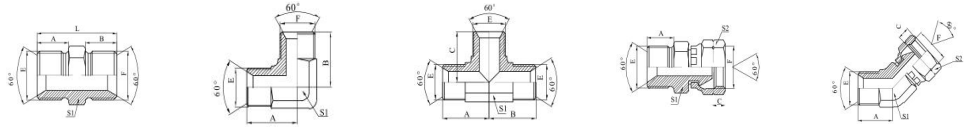

1B 1B9 AB 2B 2B4

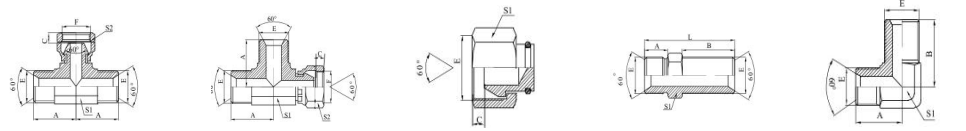

BB CB 9B 6B 6B9

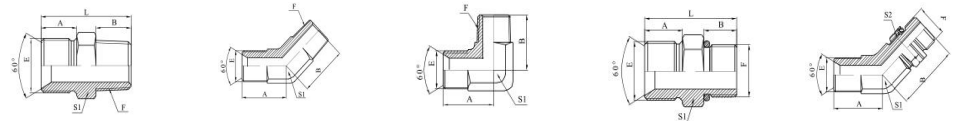

1BT-SP 1BT4-SP 1BT9-SP 1BG 1BG4-OG

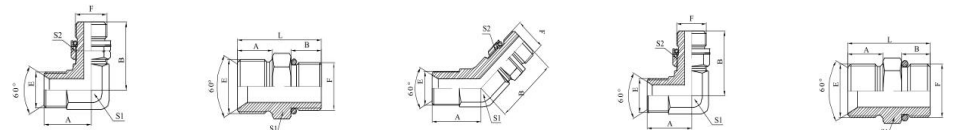

1BG9-OG 1BH 1BH4-OG 1BH9-OG 1BO

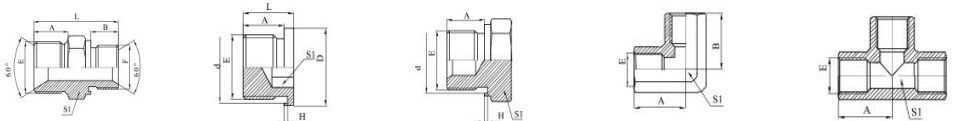

1B-WD 4BN-WD 4B-WD 7B9-PK GB-PK

美制螺纹O形圈
平面密封
ORFS接头
ORFS FITTING

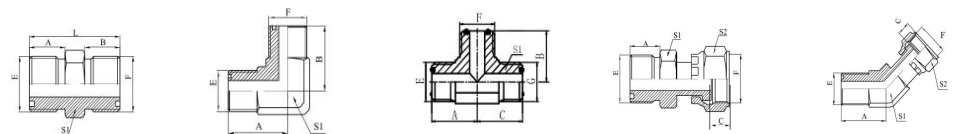

1F 1F9 AF 2F 2F4

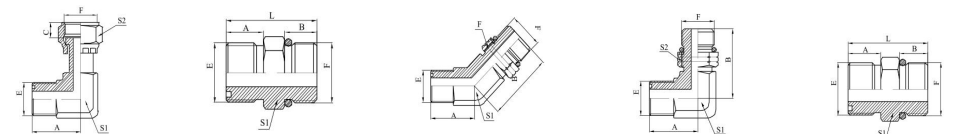

2F9 1FO 1FO4-OG 1FO9-OG 1FG



1FG4-OG 1FG9-OG

过渡接头
ADAPTER

美制锥管螺纹
NPT接头
NPT Thread
Fitting

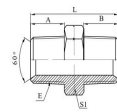

1N

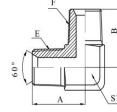

1N9

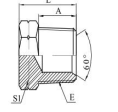

4N

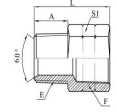

5N

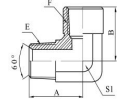

5N9

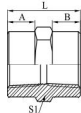

7N

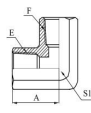

7N9-PK

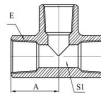

GN-PK

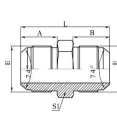

1J

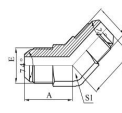

1J4

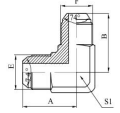

1J9

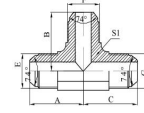

AJ

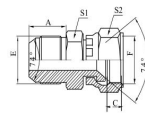

2J

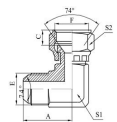

2J9

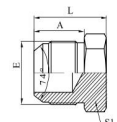

4J

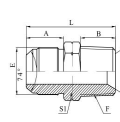

1JN

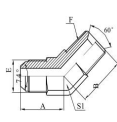

1JN4

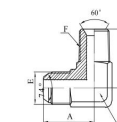

1JN9

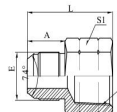

5JN

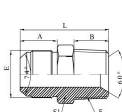

1JT-SP

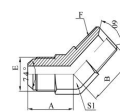

1JT4-SP

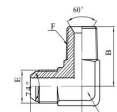

1JT9-SP

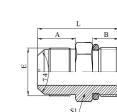

1JO

美制螺纹74°
锥面扩口接头
JIC 74° Cone
Flared Tube
Fitting

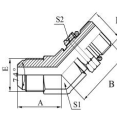

1JO4-OG

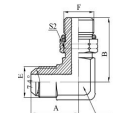

1JO9-OG

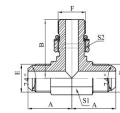

AJOJ-OG

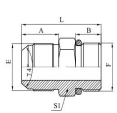

1JG

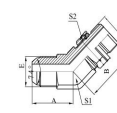

1JG4-OG

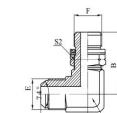

1JG9-OG

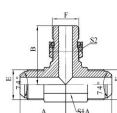

AJGJ-OG

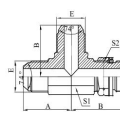

AJJG-OG

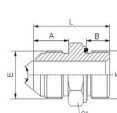

1JB-WD

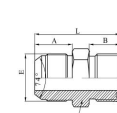

1JF

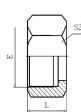

NB200

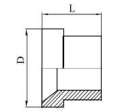

NB300

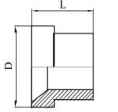

NB500

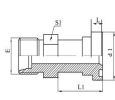
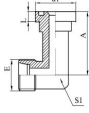
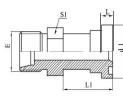
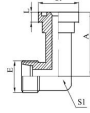
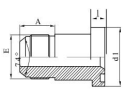
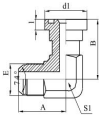
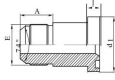
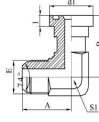
过渡接头 ADAPTER	ISO 6162 法兰接头 ISO 6162 Flange Fitting	 1CFL 1DFL	 1CFL9 1DFL9	 1DFS	 1DFS9	 1JFL
		 1JFL9	 1JFS	 1JFS9		